

CutPRO[®] Clothing



THE NEXT GENERATION OF CUT RESISTANT CLOTHING

LEVEL
A5
CUT RESISTANCE
ANSI/ISEA 105-2016

LEVEL
3
ABRASION RESISTANCE
EN 388

LEVEL
4
TEAR RESISTANCE
EN 388

LEVEL
4
PUNCTURE RESISTANCE
EN 388

LEVEL
E
CUT RESISTANCE (TDM-100 Test)
EN 388

Contents

2. Cut Resistant Clothing

3. About Cut-Tex® PRO

JACKETS

4. 100200 Turtleneck Zipped Jacket with Tape and Breathable Back

5. 800530 Turtleneck Zipped Jacket with Tape and Breathable Underarms

SHIRTS

6. 100210 Collared Top with Breathable Back

7. 100218 Crew Neck Top with Breathable Back

8. 100201 Crew Neck Top with Half Armguard and Belly Patch

9. 100202 Crew Neck Top with Half Armguard

10. 100212 Crew Neck Top with Full Armguard

11. 100217 Crew Neck Top with Full Armguard and Belly Patch

12. 100221 Turtleneck Top with Rear Half Zip and Breathable Back

13. 100222 Turtleneck Top with Rear Half Zip

SLEEVES

14. 100205 Pull on Sleeve

15. 100208 Cut Resistant Sleeve V3

TROUSERS

16. 100206 Trousers with Front Protection

17. 100216 Trousers with Front and Back Protection

APRONS

18. 100213 Full Length Apron

19. 100214 Half Apron

20. 100215 Split Apron

LAB COATS

21. 100207 Lab Coat

INFORMATION

22. Size Guide

23. Important information

24. Contact

Introducing CutPRO®

CutPRO® is high performance, cut resistant work wear, designed to offer reliable, ultra-durable and thoroughly field-tested protection to professionals at risk of cut-injuries in the workplace.

Made from specialist fabric Cut-Tex® PRO, all garments offer outstanding levels of cut, tear, abrasion and puncture resistance, while being durable, lightweight and comfortable.

Used across the CutPRO® range, this highly acclaimed fabric provides the best possible defence against cuts and lacerations and withstands frequent laundering.

CutPRO® garments are fully CE certified and recognised by the BSIF, with a 6 month workmanship guarantee.

More information

- Cuts and lacerations can cause rapid blood loss, infection, permanent damage to soft tissues, and even death.
- These incidents cost firms time and money, they highlight a serious failure in employers' duty of care; possibly leading to reputation loss and criminal prosecution.
- Cheaper alternatives are likely to offer inferior protection, costing customers more in replacements while compromising safety.

CutPRO® Certifications and Associations

We are proudly CE, UKCA, and ISO9001:2015 certified with UKAS accreditation. This means you can rest assured that our garments meet the standards necessary to ensure the safety of your team



As our garments are fully CE certified, they can be resold in the European Union as Personal Protective Equipment (PPE) which meets EU standards for health, safety, and environmental protection.



As our garments carry the UKCA mark, they conform to UK standards of PPE.



The British Safety Industry Federation (BSiF) is the trade association for the Personal Protective Equipment (PPE) Regulation and has Primary Authority status with Trading Standards. As a BSiF Registered Safety Supplier, our products and services are certified to meet the appropriate EU standard.



Visit our website: www.cut-pro.com

T: +44 (0) 845 5193 953 | E: info@cut-pro.com

About Cut-Tex[®] PRO

Cut-Tex[®] PRO

The Ultimate Cut Protection[™]

Cut-Tex[®] PRO is an ultra-high performance cut and slash resistant fabric, comfortable to wear, fully machine washable and of truly exceptional strength and durability - making it the ideal material for CutPRO[®] Cut Resistant Clothing.

As you can see below, Cut-Tex[®] PRO performs very highly in all cut, abrasion, tear and puncture tests:

Cut-Tex[®] PRO Performance Chart:

> **Cut Resistance** - ANSI/ISEA 105-2016 Blade Resistance Levels A1-A9



> **Abrasion Resistance** - EN 388:2016 Abrasion Resistance Levels 1-4



> **Tear Resistance** - EN 388:2016 Tear Resistance Levels 1-4



> **Puncture Resistance** - EN 388:2016 Puncture Resistance Levels 1-4



> **Cut Resistance** - EN ISO 13997 (TDM-100 Test)





Product: CutPRO® Turtleneck Zipped Jacket with Tape and Breathable Back

Model #: 100200

CutPRO® Cut Resistant Jackets are manufactured using Cut-Tex® PRO, offering outstanding tested and certified levels of cut, abrasion, tear and puncture resistance.



Features and Benefits

- Cut-Tex® PRO is used to provide excellent cut resistance
- Full front, arms, neck and shoulder protection
- Breathable polyester back
- Thumb holes
- Bright yellow tape
- Full front zip
- 100% latex free

Bespoke features available – please contact us for further details

*Minimum order quantities apply Logo embroidery

- Logo embroidery

Suitable for professionals working in the following industries:

- Glass and glazing
- Metal
- Ceramics
- Industrial manufacturing
- Recycling

Material Content

Cut-Tex® PRO, Polyester

Cut Resistance

EN ISO 13997 (TDM-100 Test) Level E

ANSI/ISEA 105-2016 Level A5

Abrasion Resistance

EN 388:2016 Level 3

Tear Resistance

EN 388:2016 Level 4

Puncture Resistance

EN 388:2016 Level 4

Sizes

S - 5XL (See sizing guide on page 22)

Colour

Cut-Tex® PRO - Grey Marl
Polyester - Black

Other colour options available in non-Cut-Tex® PRO materials subject to minimum order volumes. Please contact us for more information

Place of Manufacture

UK - CE PPE Regulation (EU) 2016/425



EN 388



3X44E



Protective areas using 100% Cut-Tex® PRO



Non-protected areas

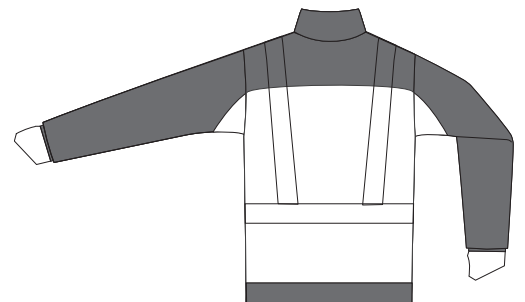

CutPRO® branded products are unavailable in Canada, please contact us for other available branding options.
UKCA module B 0338 Approved Body: BTG, Unit 6 Wheel Forge Way, Trafford Park, Manchester, M17 1EH, United Kingdom.
The Declaration of Conformity may be found on our website at: <https://cut.ly/cut-pro-doc>



Visit our website: www.cut-pro.com

T: +44 (0) 845 5193 953 | E: info@cut-pro.com



Product: CutPRO® Turtleneck Zipped Jacket with Tape and Breathable Underarms

Model #: 800530

CutPRO® Cut Resistant Jackets are manufactured using Cut-Tex® PRO, offering outstanding tested and certified levels of cut, abrasion, tear and puncture resistance.



Features and Benefits

- Cut-Tex® PRO is used to provide excellent cut resistance
- Full front, arms, neck and back protection
- Breathable underarms
- Thumb holes
- Bright yellow tape
- Full front zip
- 100% latex free

Bespoke features available – please contact us for further details

*Minimum order quantities apply Logo embroidery

- Logo embroidery

Suitable for professionals working in the following industries:

- Glass and glazing
- Metal
- Ceramics
- Industrial manufacturing
- Recycling

Material Content

Cut-Tex® PRO, Polyester

Cut Resistance

EN ISO 13997 (TDM-100 Test) Level E

ANSI/ISEA 105-2016 Level A5

Abrasion Resistance

EN 388:2016 Level 3

Tear Resistance

EN 388:2016 Level 4

Puncture Resistance

EN 388:2016 Level 4

Sizes

S - 5XL (See sizing guide on page 22)

Colour

Cut-Tex® PRO - Grey Marl
Polyester - Black

Other colour options available in non-Cut-Tex® PRO materials subject to minimum order volumes. Please contact us for more information

Place of Manufacture

UK - CE PPE Regulation (EU) 2016/425



■ Protective areas using 100% Cut-Tex® PRO

□ Non-protected areas

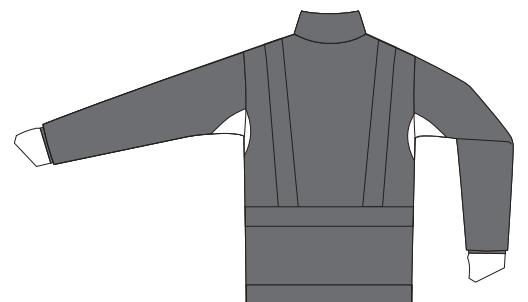
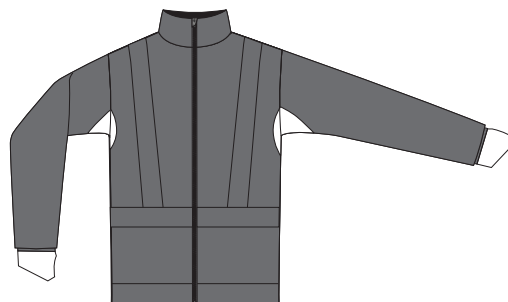

CutPRO® branded products are unavailable in Canada, please contact us for other available branding options.
UKCA module B 0338 Approved Body: BTGG, Unit 6 Wheel Forge Way, Trafford Park, Manchester, M17 1EH, United Kingdom.
The Declaration of Conformity may be found on our website at: <https://cutt.ly/cut-pro-doc>



Visit our website: www.cut-pro.com

T: +44 (0) 845 5193 953 | E: info@cut-pro.com



Product: CutPRO® Collared Top with Breathable Back

Model #: 100210

CutPRO® Cut Resistant Tops are manufactured using Cut-Tex® PRO, offering outstanding tested and certified levels of cut, abrasion, tear and puncture resistance.



Features and Benefits

- Cut-Tex® PRO is used to provide excellent cut resistance
- Full front, neck and arm protection
- Breathable polyester back
- Thumb holes
- 8" length zip
- Shoulder and elbow patches
- 100% latex free

Bespoke features available – please contact us for further details

*Minimum order quantities apply Logo embroidery

- Logo embroidery

Suitable for professionals working in the following industries:

- Glass and glazing
- Metal
- Ceramics
- Industrial manufacturing
- Recycling

Material Content

Cut-Tex® PRO, Polyester, Cotton

Cut Resistance

EN ISO 13997 (TDM-100 Test) Level E

ANSI/ISEA 105-2016 Level A5

Abrasion Resistance

EN 388:2016 Level 3

Tear Resistance

EN 388:2016 Level 4

Puncture Resistance

EN 388:2016 Level 4

Sizes

S - 5XL (See sizing guide on page 22)

Colour

Cut-Tex® PRO - Grey Marl
Piping - Orange
Polycotton - Grey

Other colour options available in non-Cut-Tex® PRO materials subject to minimum order volumes. Please contact us for more information

Place of Manufacture

UK - CE PPE Regulation (EU) 2016/425



■ Protective areas using 100% Cut-Tex® PRO

□ Non-protected areas



CutPRO® branded products are unavailable in Canada, please contact us for other available branding options.
UKCA module B 0338 Approved Body: BTTG, Unit 6 Wheel Forge Way, Trafford Park, Manchester, M17 1EH, United Kingdom.
The Declaration of Conformity may be found on our website at: <https://cut.ly/cut-pro-doc>



Visit our website: www.cut-pro.com

T: +44 (0) 845 5193 953 | E: info@cut-pro.com

Product: CutPRO® Crew Neck Top with Breathable Back

Model #: 100218

CutPRO® Cut Resistant Tops are manufactured using Cut-Tex® PRO, offering outstanding tested and certified levels of cut, abrasion, tear and puncture resistance.



Features and Benefits

- Cut-Tex® PRO is used to provide excellent cut resistance
- Full front, arms and shoulder protection
- Breathable polyester back and underarms
- Thumb holes
- Crew neck
- 100% latex free

Bespoke features available – please contact us for further details

*Minimum order quantities apply Logo embroidery

- Logo embroidery

Suitable for professionals working in the following industries:

- Glass and glazing
- Metal
- Ceramics
- Industrial manufacturing
- Recycling

Material Content

Cut-Tex® PRO, Polyester

Cut Resistance

EN ISO 13997 (TDM-100 Test) Level E

ANSI/ISEA 105-2016 Level A5

Abrasion Resistance

EN 388:2016 Level 3

Tear Resistance

EN 388:2016 Level 4

Puncture Resistance

EN 388:2016 Level 4

Sizes

S - 5XL (See sizing guide on page 22)

Colour

Cut-Tex® PRO - Grey Marl
Polyester - Orange

Other colour options available in non-Cut-Tex® PRO materials subject to minimum order volumes. Please contact us for more information

Place of Manufacture

UK - CE PPE Regulation (EU) 2016/425



■ Protective areas using 100% Cut-Tex® PRO

□ Non-protected areas

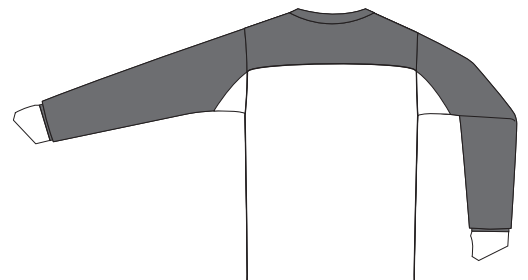
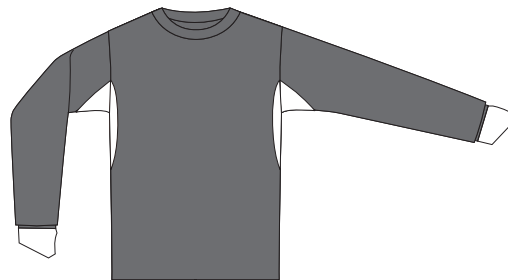

CutPRO® branded products are unavailable in Canada, please contact us for other available branding options.
UKCA module B 0338 Approved Body: BTG, Unit 6 Wheel Forge Way, Trafford Park, Manchester, M17 1EH, United Kingdom.
The Declaration of Conformity may be found on our website at: <https://cut.ly/cut-pro-doc>



Product: CutPRO® Crew Neck Top with Half Armguard and Belly Patch

Model #: 100201

CutPRO® Cut Resistant Tops are manufactured using Cut-Tex® PRO, offering outstanding tested and certified levels of cut, abrasion, tear and puncture resistance.



Features and Benefits

- Cut-Tex® PRO is used to provide excellent cut resistance
- Abdominal and forearm protection
- Breathable polyester chest, shoulders and back
- Thumb holes
- Crew neck
- 100% latex free

Bespoke features available – please contact us for further details

*Minimum order quantities apply Logo embroidery

- Logo embroidery

Suitable for professionals working in the following industries:

- Glass and glazing
- Metal
- Ceramics
- Industrial manufacturing
- Recycling

Material Content

Cut-Tex® PRO, Polyester

Cut Resistance

EN ISO 13997 (TDM-100 Test) Level E

ANSI/ISEA 105-2016 Level A5

Abrasion Resistance

EN 388:2016 Level 3

Tear Resistance

EN 388:2016 Level 4

Puncture Resistance

EN 388:2016 Level 4

Sizes

S - 5XL (See sizing guide on page 22)

Colour

Cut-Tex® PRO - Grey Marl
Polyester - Orange

Other colour options available in non-Cut-Tex® PRO materials subject to minimum order volumes. Please contact us for more information

Place of Manufacture

UK - CE PPE Regulation (EU) 2016/425



■ Protective areas using 100% Cut-Tex® PRO

□ Non-protected areas

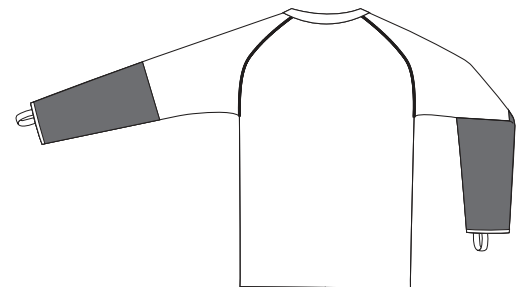
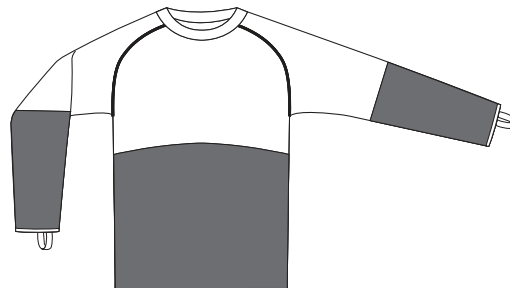

CutPRO® branded products are unavailable in Canada, please contact us for other available branding options.
UKCA module B 0338 Approved Body: BTG, Unit 6 Wheel Forge Way, Trafford Park, Manchester, M17 1EH, United Kingdom.
The Declaration of Conformity may be found on our website at: <https://cut.ly/cut-pro-doc>



Visit our website: www.cut-pro.com

T: +44 (0) 845 5193 953 | E: info@cut-pro.com

Product: CutPRO® Crew Neck Top with Half Armguard

Model #: 100202

CutPRO® Cut Resistant Tops are manufactured using Cut-Tex® PRO, offering outstanding tested and certified levels of cut, abrasion, tear and puncture resistance.



Features and Benefits

- Cut-Tex® PRO is used to provide excellent cut resistance
- Forearm protection
- Breathable polyester front, shoulders and back
- Thumb holes
- Crew neck
- 100% latex free

Bespoke features available – please contact us for further details

*Minimum order quantities apply Logo embroidery

- Logo embroidery

Suitable for professionals working in the following industries:

- Glass and glazing
- Metal
- Ceramics
- Industrial manufacturing
- Recycling

Material Content

Cut-Tex® PRO, Polyester

Cut Resistance

EN ISO 13997 (TDM-100 Test) Level E

ANSI/ISEA 105-2016 Level A5

Abrasion Resistance

EN 388:2016 Level 3

Tear Resistance

EN 388:2016 Level 4

Puncture Resistance

EN 388:2016 Level 4

Sizes

S - 5XL (See sizing guide on page 22)

Colour

Cut-Tex® PRO - Grey Marl
Polyester - Orange

Other colour options available in non-Cut-Tex® PRO materials subject to minimum order volumes. Please contact us for more information

Place of Manufacture

UK - CE PPE Regulation (EU) 2016/425



■ Protective areas using 100% Cut-Tex® PRO

□ Non-protected areas

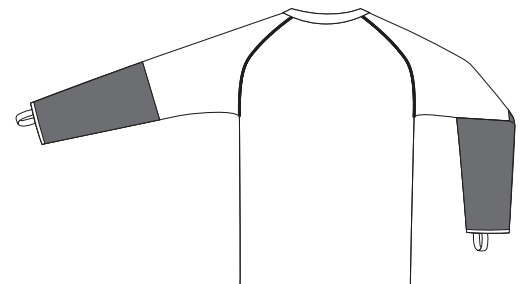
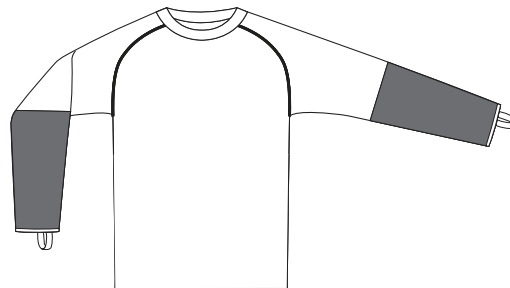

CutPRO® branded products are unavailable in Canada, please contact us for other available branding options.
UKCA module B 0338 Approved Body: BTTG, Unit 6 Wheel Forge Way, Trafford Park, Manchester, M17 1EH, United Kingdom.
The Declaration of Conformity may be found on our website at: <https://cutt.ly/cut-pro-doc>



Product: CutPRO® Crew Neck Top with Full Armguard

Model #: 100212

CutPRO® Cut Resistant Tops are manufactured using Cut-Tex® PRO, offering outstanding tested and certified levels of cut, abrasion, tear and puncture resistance.



Features and Benefits

- Cut-Tex® PRO is used to provide excellent cut resistance
- Full arm and shoulder protection
- Breathable polyester front and back
- Thumb holes
- 100% latex free

Bespoke features available – please contact us for further details

*Minimum order quantities apply Logo embroidery

- Logo embroidery

Suitable for professionals working in the following industries:

- Glass and glazing
- Metal
- Ceramics
- Industrial manufacturing
- Recycling

Material Content

Cut-Tex® PRO, Polyester

Cut Resistance

EN ISO 13997 (TDM-100 Test) Level E

ANSI/ISEA 105-2016 Level A5

Abrasion Resistance

EN 388:2016 Level 3

Tear Resistance

EN 388:2016 Level 4

Puncture Resistance

EN 388:2016 Level 4

Sizes

S - 5XL (See sizing guide on page 22)

Colour

Cut-Tex® PRO - Grey Marl
 Polyester - Orange
 Other colour options available in non-Cut-Tex® PRO materials subject to minimum order volumes. Please contact us for more information

Place of Manufacture

UK - CE PPE Regulation (EU) 2016/425



■ Protective areas using 100% Cut-Tex® PRO

□ Non-protected areas

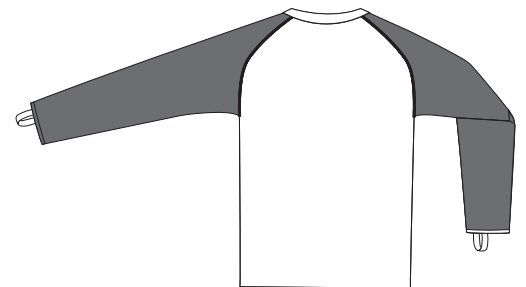
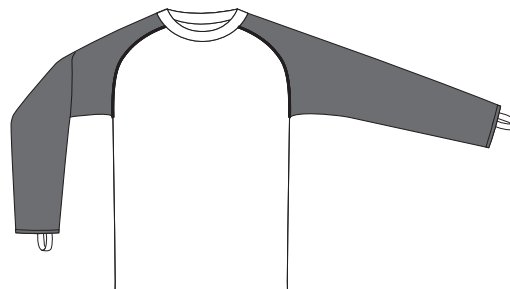

CutPRO® branded products are unavailable in Canada, please contact us for other available branding options.
 UKCA module B 0338 Approved Body: BTTG, Unit 6 Wheel Forge Way, Trafford Park, Manchester, M17 1EH, United Kingdom.
 The Declaration of Conformity may be found on our website at: <https://cutt.ly/cut-pro-doc>



Visit our website: www.cut-pro.com

T: +44 (0) 845 5193 953 | E: info@cut-pro.com



Product: CutPRO® Crew Neck Top with Full Armguard and Belly Patch

Model #: 100217

CutPRO® Cut Resistant Tops are manufactured using Cut-Tex® PRO, offering outstanding tested and certified levels of cut, abrasion, tear and puncture resistance.



Features and Benefits

- Cut-Tex® PRO is used to provide excellent cut resistance
- Full arm, shoulder and abdomen protection
- Breathable polyester chest and back
- Thumb holes
- 100% latex free

Bespoke features available – please contact us for further details

*Minimum order quantities apply Logo embroidery

- Logo embroidery

Suitable for professionals working in the following industries:

- Glass and glazing
- Metal
- Ceramics
- Industrial manufacturing
- Recycling

Material Content

Cut-Tex® PRO, Polyester

Cut Resistance

EN ISO 13997 (TDM-100 Test) Level E

ANSI/ISEA 105-2016 Level A5

Abrasion Resistance

EN 388:2016 Level 3

Tear Resistance

EN 388:2016 Level 4

Puncture Resistance

EN 388:2016 Level 4

Sizes

S - 5XL (See sizing guide on page 22)

Colour

Cut-Tex® PRO - Grey Marl
 Polyester - Orange
 Other colour options available in non-Cut-Tex® PRO materials subject to minimum order volumes. Please contact us for more information

Place of Manufacture

UK - CE PPE Regulation (EU) 2016/425



■ Protective areas using 100% Cut-Tex® PRO

□ Non-protected areas

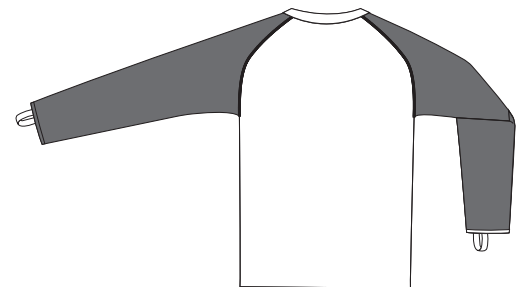
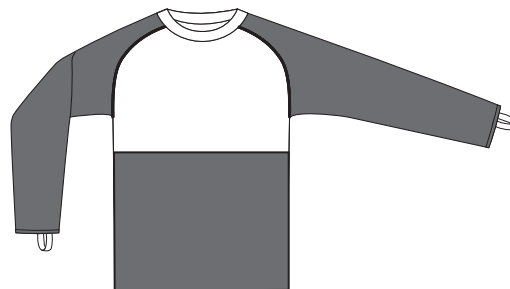

CutPRO® branded products are unavailable in Canada, please contact us for other available branding options.
 UKCA module B 0338 Approved Body: BTTG, Unit 6 Wheel Forge Way, Trafford Park, Manchester, M17 1EH, United Kingdom.
 The Declaration of Conformity may be found on our website at: <https://cutt.ly/cut-pro-doc>



Visit our website: www.cut-pro.com

T: +44 (0) 845 5193 953 | E: info@cut-pro.com



Product: CutPRO® Turtleneck Top with Rear Half Zip and Breathable Back

Model #: 100221

CutPRO® Cut Resistant Turtleneck Pullovers are manufactured using Cut-Tex® PRO, offering outstanding tested and certified levels of cut, abrasion, tear and puncture resistance.



Features and Benefits

- Cut-Tex® PRO is used to provide excellent cut resistance
- Full front, arms, neck and shoulder protection
- Breathable polyester back and underarms
- Thumb holes
- 100% latex free

Additional features available - please contact us for further details

*Minimum order quantities apply

- Logo embroidery

Suitable for professionals working in the following industries:

- Glass and glazing
- Metal
- Ceramics
- Industrial manufacturing
- Recycling

Material Content

Cut-Tex® PRO, Polyester

Cut Resistance

EN ISO 13997 (TDM-100 Test) Level E

ANSI/ISEA 105-2016 Level A5

Abrasion Resistance

EN 388:2016 Level 3

Tear Resistance

EN 388:2016 Level 4

Puncture Resistance

EN 388:2016 Level 4

Sizes

S - 5XL (See sizing guide on page 22)

Colour

Cut-Tex® PRO - Grey Marl
Polyester - Black, Grey

Other colour options available in non-Cut-Tex® PRO materials subject to minimum order volumes. Please contact us for more information

Place of Manufacture

UK - CE PPE Regulation (EU) 2016/425



Protective areas using 100% Cut-Tex® PRO



Non-protected areas

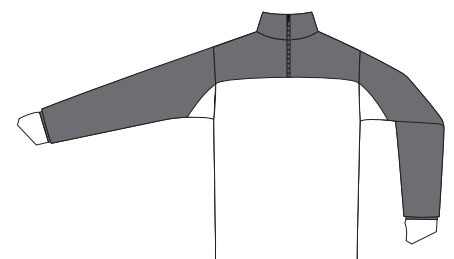
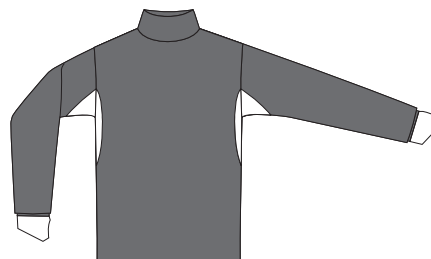

CutPRO® branded products are unavailable in Canada, please contact us for other available branding options.
UKCA module B 0338 Approved Body: BTTG, Unit 6 Wheel Forge Way, Trafford Park, Manchester, M17 1EH, United Kingdom.
The Declaration of Conformity may be found on our website at: <https://cutt.ly/cut-pro-doc>



Visit our website: www.cut-pro.com

T: +44 (0) 845 5193 953 | E: info@cut-pro.com



Product: CutPRO® Turtleneck Top with Rear Half Zip

Model #: 100222



CutPRO® Cut Resistant Turtleneck Pullovers are manufactured using Cut-Tex® PRO, offering outstanding tested and certified levels of cut, abrasion, tear and puncture resistance.



Features and Benefits

- Cut-Tex® PRO is used to provide excellent cut resistance
- Full front, arms, neck, shoulder and back protection
- Thumb holes
- 100% latex free

Additional features available - please contact us for further details

*Minimum order quantities apply

- Logo embroidery

Suitable for professionals working in the following industries:

- Glass and glazing
- Metal
- Ceramics
- Industrial manufacturing
- Recycling

Material Content

Cut-Tex® PRO, Polyester

Cut Resistance

EN ISO 13997 (TDM-100 Test) Level E

ANSI/ISEA 105-2016 Level A5

Abrasion Resistance

EN 388:2016 Level 3

Tear Resistance

EN 388:2016 Level 4

Puncture Resistance

EN 388:2016 Level 4

Sizes

S - 5XL (See sizing guide on page 22)

Colour

Cut-Tex® PRO - Grey Marl

Place of Manufacture

UK - CE PPE Regulation (EU) 2016/425



Protective areas using 100% Cut-Tex® PRO



Non-protected areas

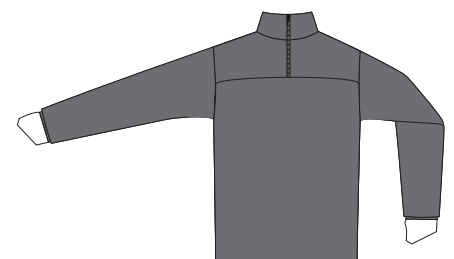
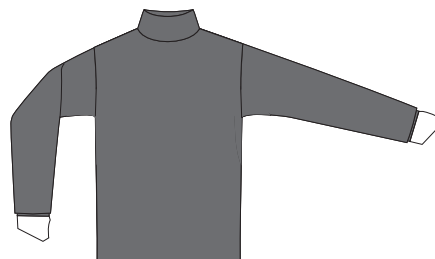

CutPRO® branded products are unavailable in Canada, please contact us for other available branding options. UKCA module B 0338 Approved Body: BTTG, Unit 6 Wheel Forge Way, Trafford Park, Manchester, M17 1EH, United Kingdom. The Declaration of Conformity may be found on our website at: <https://cutt.ly/cut-pro-doc>



Visit our website: www.cut-pro.com

T: +44 (0) 845 5193 953 | E: info@cut-pro.com



Product: CutPRO® Pull on Sleeve

Model #: 100205



CutPRO® Cut Resistant Pull on Sleeves are manufactured using Cut-Tex® PRO – offering absolutely outstanding, tested and certified levels of cut, abrasion, tear and puncture resistance.

Features and Benefits

- Cut-Tex® PRO is used to provide excellent cut resistance
- Forearm protection
- Thumb holes
- 100% latex free

Suitable for professionals working in the following industries:

- Glass and glazing
- Metal
- Ceramics
- Industrial manufacturing
- Recycling

Material Content

Cut-Tex® PRO, Polyester

Cut Resistance

EN ISO 13997 (TDM-100 Test) Level E

ANSI/ISEA 105-2016 Level A5

Abrasion Resistance

EN 388:2016 Level 3

Tear Resistance

EN 388:2016 Level 4

Puncture Resistance

EN 388:2016 Level 4

Sizes

S - XL (See sizing guide on page 22)

Colour

Cut-Tex® PRO - Grey Marl

Other colour options available in non-Cut-Tex® PRO materials subject to minimum order volumes. Please contact us for more information

Place of Manufacture

UK - CE PPE Regulation (EU) 2016/425



■ **Protective areas using 100% Cut-Tex® PRO**

□ **Non-protected areas**

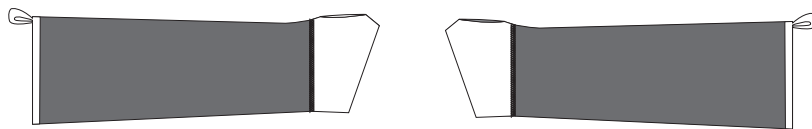

CutPRO® branded products are unavailable in Canada, please contact us for other available branding options.
UKCA module B 0338 Approved Body: BTTG, Unit 6 Wheel Forge Way, Trafford Park, Manchester, M17 1EH, United Kingdom.
The Declaration of Conformity may be found on our website at: <https://cutt.ly/cut-pro-doc>



Visit our website: www.cut-pro.com

T: +44 (0) 845 5193 953 | E: info@cut-pro.com



Product: CutPRO® Cut Resistant Sleeve V3

Model #: 100208

CutPRO® Cut Resistant Sleeves are manufactured using Cut-Tex® PRO – offering absolutely outstanding, tested and certified levels of cut, abrasion, tear and puncture resistance.



Features & Benefits

- Sold in pairs
- Cut-Tex® PRO is used to provide excellent cut resistance
- Worn tight around the forearm
- Thumbhole for improved fit
- 100% Latex free

Suitable for professionals working in the following industries:

- Glass and glazing
- Metal
- Ceramics
- Industrial manufacturing
- Recycling

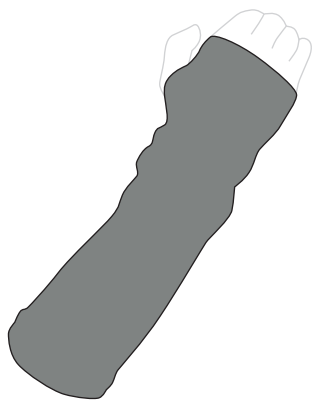

Protective areas using 100% Cut-Tex® PRO

Blade Cut Resistance

EN 388:2016	Level 5
EN 388:2016	Level E (TDM-100 Test)
ISO 13997:1999	Level 5
ANSI/ISEA 105-2016	Level A5

Tear Resistance

EN 388:2016	Level 4
-------------	---------

Puncture Resistance

EN 388:2016	Level 4
-------------	---------

Abrasion Resistance

EN 388:2016	Level 3
Dimensional Stability Test	Achieved excellent results

CE Marking	Cat II PPE Directive
------------	----------------------

Sizes	S - XL
-------	--------

Clothing Care	Machine washable up to 40° Celsius
---------------	------------------------------------

Colour	Grey
--------	------

Place of Manufacture	UK - CE PPE Regulation (EU) 2016/425
----------------------	--------------------------------------



CutPRO® branded products are unavailable in Canada, please contact us for other available branding options.
UKCA module B 0338 Approved Body: BTTG, Unit 6 Wheel Forge Way, Trafford Park, Manchester, M17 1EH, United Kingdom.
The Declaration of Conformity may be found on our website at: <https://cutt.ly/cut-pro-doc>



Visit our website: www.cut-pro.com

T: +44 (0) 845 5193 953 | E: info@cut-pro.com



Product: CutPRO® Trousers with Front Protection

Model #: 100206

CutPRO® Cut Resistant Trousers are manufactured using Cut-Tex® PRO – offering absolutely outstanding, tested and certified levels of cut, abrasion, tear and puncture resistance.



Features and Benefits

- Cut-Tex® PRO is used to provide excellent cut resistance
- Full front leg protection
- Knee patches
- Bright orange piping
- Belt loops
- Front and rear pockets
- Side leg pocket
- D-ring attachment
- 100% latex free

Bespoke features available – please contact us for further details

*Minimum order quantities apply Logo embroidery

- Garment available with front and back protection (100216)

Suitable for professionals working in the following industries:

- Glass and glazing
- Metal
- Ceramics
- Industrial manufacturing
- Recycling

■ **Protective areas using 100% Cut-Tex® PRO**

□ **Non-protected areas**

CutPRO® branded products are unavailable in Canada, please contact us for other available branding options.
 UKCA module B 0338 Approved Body: BTTG, Unit 6 Wheel Forge Way, Trafford Park, Manchester, M17 1EH, United Kingdom.
 The Declaration of Conformity may be found on our website at: <https://cutt.ly/cut-pro-doc>

Material Content

Cut-Tex® PRO, Nylon, Polyester, Cotton, Velcro

Cut Resistance

EN ISO 13997 (TDM-100 Test) Level E

ANSI/ISEA 105-2016 Level A5

Abrasion Resistance

EN 388:2016 Level 3

Tear Resistance

EN 388:2016 Level 4

Puncture Resistance

EN 388:2016 Level 4

Sizes

Waist: 30"/32"/34"/36"/38"/40"/42"/44"/46"/48"
 Adjustable leg lengths between 30 – 34 inches
 (See sizing guide on page 22)

Colour

Cut-Tex® PRO - Grey Marl
 Piping - Orange
 Polycotton - Grey
 Other colour options available in non-Cut-Tex® PRO materials subject to minimum order volumes. Please contact us for more information

Place of Manufacture

UK - CE PPE Regulation (EU) 2016/425

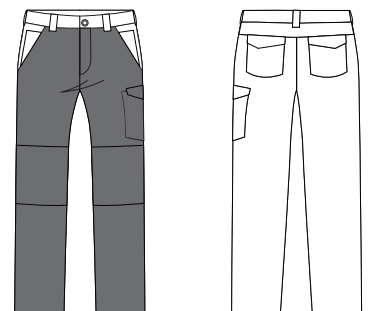

Visit our website: www.cut-pro.com

T: +44 (0) 845 5193 953 | E: info@cut-pro.com



Product: CutPRO® Trousers with Front and Back Protection

Model #: 100216

CutPRO® Cut Resistant Trousers are manufactured using Cut-Tex® PRO – offering absolutely outstanding, tested and certified levels of cut, abrasion, tear and puncture resistance.



Features and Benefits

- Cut-Tex® PRO is used to provide excellent cut resistance
- Full front, lower back leg and groin protection
- Knee patches
- Bright orange piping
- Belt loops
- Rear pockets
- Side leg pocket
- D-ring attachment
- 100% latex free

Suitable for professionals working in the following industries:

- Glass and glazing
- Metal
- Ceramics
- Industrial manufacturing
- Recycling

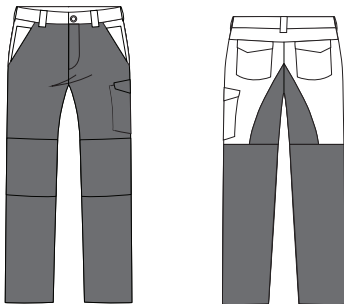

Protective areas using 100% Cut-Tex® PRO



Non-protected areas

CutPRO® branded products are unavailable in Canada, please contact us for other available branding options.
 UKCA module B 0338 Approved Body: BTG, Unit 6 Wheel Forge Way, Trafford Park, Manchester, M17 1EH, United Kingdom.
 The Declaration of Conformity may be found on our website at: <https://cutt.ly/cut-pro-doc>

Material Content

Cut-Tex® PRO, Nylon, Polyester, Cotton, Velcro

Cut Resistance

EN ISO 13997 (TDM-100 Test) Level E

ANSI/ISEA 105-2016 Level A5

Abrasion Resistance

EN 388:2016 Level 3

Tear Resistance

EN 388:2016 Level 4

Puncture Resistance

EN 388:2016 Level 4

Sizes

Waist: 30"/32"/34"/36"/38"/40"/42"/44"/46"/48"
 Adjustable leg lengths between 30 – 34 inches
 (See sizing guide on page 22)

Colour

Cut-Tex® PRO - Grey Marl
 Piping - Orange
 Polycotton - Grey
 Other colour options available in non-Cut-Tex® PRO materials subject to minimum order volumes. Please contact us for more information

Place of Manufacture

UK - CE PPE Regulation (EU) 2016/425



Visit our website: www.cut-pro.com

T: +44 (0) 845 5193 953 | E: info@cut-pro.com



Product: CutPRO® Full Length Apron

Model #: 100213



CutPRO® Cut Resistant Aprons are manufactured using Cut-Tex® PRO – offering absolutely outstanding, tested and certified levels of cut, abrasion, tear and puncture resistance.

Features and Benefits

- Cut-Tex® PRO is used to provide excellent cut resistance
- Full cut protection
- Clip-on adjustable straps
- 100% latex free

Suitable for professionals working in the following industries:

- Glass and glazing
- Metal
- Ceramics
- Industrial manufacturing
- Recycling

Material Content

Cut-Tex® PRO, Nylon, Polyester, Cotton

Cut Resistance

EN ISO 13997 (TDM-100 Test) Level E

ANSI/ISEA 105-2016 Level A5

Abrasion Resistance

EN 388:2016 Level 3

Tear Resistance

EN 388:2016 Level 4

Puncture Resistance

EN 388:2016 Level 4

Sizes One size (See sizing guide on page 22)

Colour Cut-Tex® PRO - Grey Marl

Place of Manufacture UK - CE PPE Regulation (EU) 2016/425



■ Protective areas using 100% Cut-Tex® PRO

□ Non-protected areas



CutPRO® branded products are unavailable in Canada, please contact us for other available branding options.
 UKCA module B 0338 Approved Body: BTTC, Unit 6 Wheel Forge Way, Trafford Park, Manchester, M17 1EH, United Kingdom.
 The Declaration of Conformity may be found on our website at: <https://cutt.ly/cut-pro-doc>



Visit our website: www.cut-pro.com

T: +44 (0) 845 5193 953 | E: info@cut-pro.com



Product: CutPRO® Half Apron

Model #: 100214

CutPRO® Cut Resistant Aprons are manufactured using Cut-Tex® PRO – offering absolutely outstanding, tested and certified levels of cut, abrasion, tear and puncture resistance.



Features and Benefits

- Cut-Tex® PRO is used to provide excellent cut resistance
- Full cut protection
- Various sized pockets
- Clip-on adjustable strap
- 100% latex free

Suitable for professionals working in the following industries:

- Glass and glazing
- Metal
- Ceramics
- Industrial manufacturing
- Recycling

Material Content

Cut-Tex® PRO, Nylon, Polyester, Cotton

Cut Resistance

EN ISO 13997 (TDM-100 Test) Level E

ANSI/ISEA 105-2016 Level A5

Abrasion Resistance

EN 388:2016 Level 3

Tear Resistance

EN 388:2016 Level 4

Puncture Resistance

EN 388:2016 Level 4

Sizes One size (See sizing guide on page 22)

Colour Cut-Tex® PRO - Grey Marl

Place of Manufacture UK - CE PPE Regulation (EU) 2016/425



 **Protective areas using 100% Cut-Tex® PRO**

 **Non-protected areas**

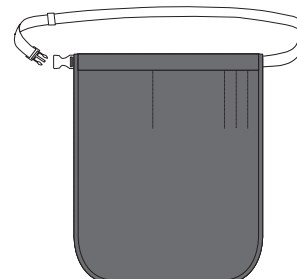
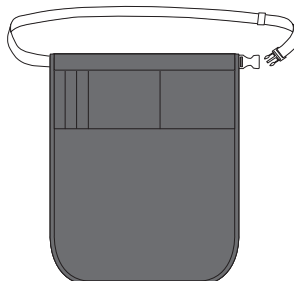

CutPRO® branded products are unavailable in Canada, please contact us for other available branding options.
UKCA module B 0338 Approved Body: BTTG, Unit 6 Wheel Forge Way, Trafford Park, Manchester, M17 1EH, United Kingdom.
The Declaration of Conformity may be found on our website at: <https://cutt.ly/cut-pro-doc>



Visit our website: www.cut-pro.com

T: +44 (0) 845 5193 953 | E: info@cut-pro.com



Product: CutPRO® Split Apron

Model #: 100215

CutPRO® Cut Resistant Aprons are manufactured using Cut-Tex® PRO – offering absolutely outstanding, tested and certified levels of cut, abrasion, tear and puncture resistance.



Features and Benefits

- Cut-Tex® PRO is used to provide excellent cut resistance
- Full cut protection
- Clip-on adjustable straps
- 100% latex free

Suitable for professionals working in the following industries:

- Glass and glazing
- Metal
- Ceramics
- Industrial manufacturing
- Recycling

Material Content

Cut-Tex® PRO, Nylon, Polyester, Cotton

Cut Resistance

EN ISO 13997 (TDM-100 Test) Level E

ANSI/ISEA 105-2016 Level A5

Abrasion Resistance

EN 388:2016 Level 3

Tear Resistance

EN 388:2016 Level 4

Puncture Resistance

EN 388:2016 Level 4

Sizes One size (See sizing guide on page 22)

Colour Cut-Tex® PRO - Grey Marl

Place of Manufacture UK - CE PPE Regulation (EU) 2016/425



■ Protective areas using 100% Cut-Tex® PRO

□ Non-protected areas

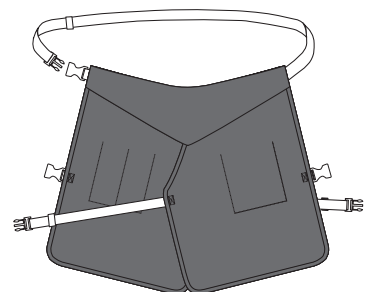
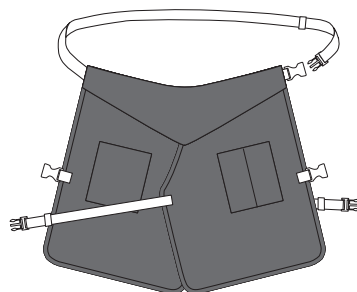

CutPRO® branded products are unavailable in Canada, please contact us for other available branding options.
 UKCA module B 0338 Approved Body: BTTG, Unit 6 Wheel Forge Way, Trafford Park, Manchester, M17 1EH, United Kingdom.
 The Declaration of Conformity may be found on our website at: <https://cutt.ly/cut-pro-doc>



Visit our website: www.cut-pro.com

T: +44 (0) 845 5193 953 | E: info@cut-pro.com

Product: CutPRO® Lab Coat

Model #: 100207



CutPRO® Cut Resistant Coats are manufactured using Cut-Tex® PRO – offering absolutely outstanding, tested and certified levels of cut, abrasion, tear and puncture resistance.



Features and Benefits

- Cut-Tex® PRO is used to provide excellent cut resistance
- Full front, neck, shoulder and arm protection
- Cool mesh back
- Inside breast pocket
- Full front zip with added Velcro
- 100% latex free

Suitable for professionals working in the following industries:

- Glass and glazing
- Metal
- Ceramics
- Industrial manufacturing
- Recycling

Material Content

Cut-Tex® PRO, Nylon

Cut Resistance

EN ISO 13997 (TDM-100 Test) Level E

ANSI/ISEA 105-2016 Level A5

Abrasion Resistance

EN 388:2016 Level 3

Tear Resistance

EN 388:2016 Level 4

Puncture Resistance

EN 388:2016 Level 4

Sizes

S - 5XL (See sizing guide on page 22)

Colour

Cut-Tex® PRO - Grey Marl

Place of Manufacture

UK - CE PPE Regulation (EU) 2016/425



■ Protective areas using 100% Cut-Tex® PRO

□ Non-protected areas

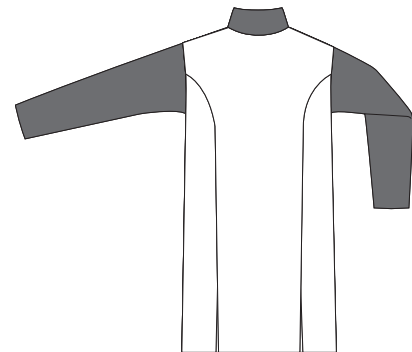

CutPRO® branded products are unavailable in Canada, please contact us for other available branding options.
 UKCA module B 0338 Approved Body: BTTG, Unit 6 Wheel Forge Way, Trafford Park, Manchester, M17 1EH, United Kingdom.
 The Declaration of Conformity may be found on our website at: <https://cutt.ly/cut-pro-doc>



Size Guide

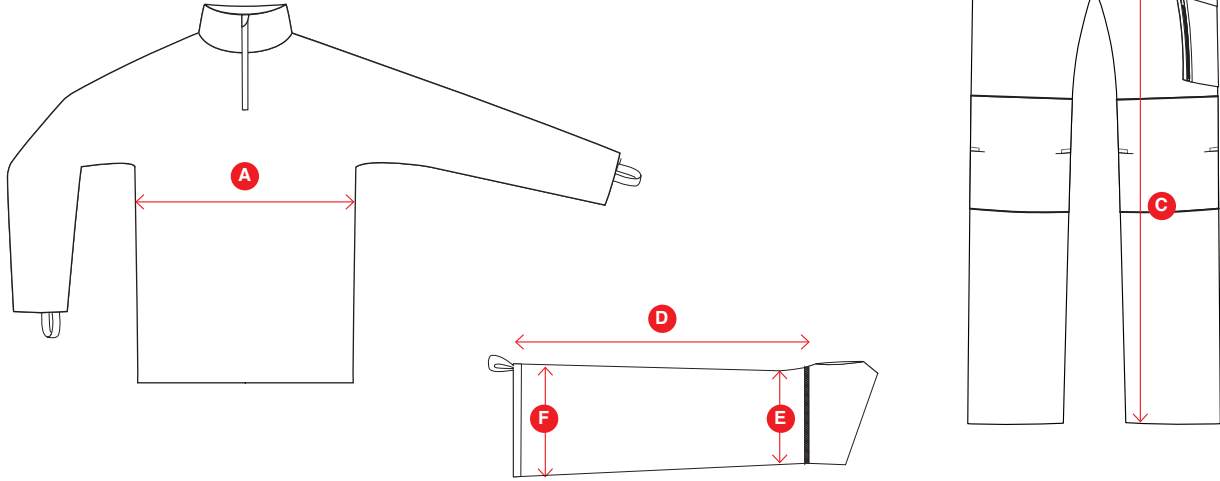

CutPRO® Chest – Size Guide

	S	M	L	XL	2XL	3XL	4XL	5XL
A To fit CHEST (inches)	38-40"	40-42"	42-44"	44-46"	46-48"	48-50"	50-52"	52-54"
To fit CHEST (cm)	92-102	102-107	107-112	112-117	117-120	120-127	127-132	132-137

CutPRO® Waist – Size Guide

B Waist Size (inches)	30"	32"	34"	36"	38"	40"	42"	44"	46"	48"
Waist Size (cm)	76	81	86	91	96	101	106	111	116	121
Tall Leg to fit 33"/86cm	33"	33"	33"	33"	33"	33"	33"	33"	N/A	N/A

CutPRO® Sleeve – Size Guide

Size	S	M	L	XL
D Actual Sleeve Length (cm)	30	32	33	34
E Actual Cuff Width - flat (cm)	9	10	11	12
F Actual Arm Width - flat (cm)	11	12	13	14

CutPRO® Apron (all with fully adjustable straps) – Size Guide

Product	Full Apron 100213	Half Apron 100214	Split Apron 100215
Actual width (cm) - waist	60	60	60
Actual length (cm)	90	75	55



Visit our website: www.cut-pro.com

T: +44 (0) 845 5193 953 | E: info@cut-pro.com

Important Information

- Do not use this product for protection from high speed or serrated blade
- Do not use this product near moving machines or where there is a risk of entanglement
- Do not use this product for food processing
- This product is designed to minimise the risk of injury from potential hazards in the industrial work space (abrasions, cuts, tears and puncture)
- This product is used only for the designated purpose, no item of PPE can provide full protection
- This product is not designed to protect the hands, gloves are to be worn when required
- This product does not protect from hypodermic needles or similar sharp pointed objects
- Care and attention must always be taken when carrying out potential hazardous activities
- Cut-Tex® PRO is an ultra-high performance cut resistant fabric. However, it is not completely cut proof.
- CutPRO® garments should be stored in a temperate dry environment.
- If you suspect aging or loss of performance with your product please contact us directly and email in photographic images.
- Do not attempt to repair CutPRO® Clothing garments yourself. Specialised PPE providers use specialist threads to stitch and sew garments.
- CutPRO® garments are not recyclable. For safe disposal please return your product to CutPRO® Clothing Ltd.

Maintenance

- Do not wear this product if damaged, always inspect prior to use
- Do not leave in a contaminated condition, launder immediately
- When not worn, store this product in cool dry conditions away from direct sunlight
- Wash dark colours separately
- Do not wash with fabric conditioner
- Reshape whilst damp



CutPRO® branded products are unavailable in Canada, please contact us for other available branding options.
UKCA module B 0338 Approved Body: BTTG, Unit 6 Wheel Forge Way, Trafford Park, Manchester, M17 1EH, United Kingdom.
The Declaration of Conformity may be found on our website at: <https://cutt.ly/cut-pro-doc>

Contact

CutPRO® Clothing Limited

Unit 603
Avenue D
Thorp Arch Estate
Wetherby
LS23 7FS
United Kingdom

T: **+44 (0) 845 5193 953**

E: **info@cut-pro.com**

W: **www.cut-pro.com**

Follow Us



/cutproclothing



/company/cutpro-cut-resistant-clothing



/cutproclothing



/CutPROclothing



Visit our website: www.cut-pro.com

T: +44 (0) 845 5193 953 | E: info@cut-pro.com