



THE NEXT GENERATION OF CUT RESISTANT CLOTHING



LEVEL
3

**ABRASION
RESISTANCE**

EN 388

LEVEL
5

**CUT
RESISTANCE**

EN 388

LEVEL
4

**TEAR
RESISTANCE**

EN 388

LEVEL
4

**PUNCTURE
RESISTANCE**

EN 388

LEVEL
E

**CUT
(TDM-100 Test)**

EN 388

Contents

2. CutPRO® Cut Resistant Clothing

3. About Cut-Tex® PRO

UPPER BODY

4. CutPRO® 100210 Pull Over Top with Half Zip Turtle Neck

5. CutPRO® 100211 Pull Over Top with Workwear Collar

6. CutPRO® 100218 Sweatshirt with Crew Neck

7. CutPRO® 100209 Sweatshirt with Turtle Neck

8. CutPRO® 100200 Zipped Jacket with Hi-Vis Tape

9. CutPRO® 100201 Top with Crew Neck and Belly Patch

10. CutPRO® 100219 Top with Half Zip Neck and Belly Patch

11. CutPRO® 100212 Crew Neck Armguard Shirt

12. CutPRO® 100203 Polo Shirt with Belly Patch

13. CutPRO® 100204 Polo Shirt without Belly Patch

14. CutPRO® 100207 Lab Coat

LOWER BODY

15. CutPRO® 100206 Trousers with Front Protection

16. CutPRO® 100216 Trousers with Front and Back Protection

APRONS and SLEEVES

17. CutPRO® 100205 Pull on Sleeve

18. CutPRO® 100213 Full Length Apron

19. CutPRO® 100214 Half Apron

20. CutPRO® 100215 Split Apron

MORE INFORMATION

21. Size Guide

22. Important information

23. Contact

About CutPRO® Cut Resistant Clothing

CutPRO® is an innovative brand of cut resistant workwear designed to protect professionals in the glass and metal industries from manual handling injuries.

Our products take cut resistant clothing to a whole new level. Our specialist fabric, Cut-Tex® PRO offers outstanding levels of cut, tear, abrasion and puncture resistance, while being durable, lightweight and comfortable. Used across the CutPRO® range, it provides the best possible defence against cuts and lacerations and gives workers personal protection they will want to wear.

CutPRO® is the result of extensive research and contribution from health and safety professionals of leading flat glass and sheet metal processing companies. As such, we know that one garment certainly does not fit all.

Together with the department of apparel of one of the UK's top universities, we have designed a range of garments perfectly suited to the glass and metal industries, yet fully adaptable a firm's individual needs.

We work with customers to ensure clothing is tailored to their unique operational risks and needs, role responsibilities, and preferences. Each garment can be customised with breathable areas, high visibility, choice of cuffs and collars, and brand colours to ensure precise protection with optimum usability.

Why Choose CutPRO®?

- High quality cut resistant clothing is essential in glass and metal handling. Cuts and lacerations can cause rapid blood loss, infection, permanent damage to soft tissues, and even death.
- Not only do manual handling incidents cost firms time and money, they highlight a serious failure in employers' duty of care, which can lead to reputation loss, and even criminal prosecution.
- Cheaper alternatives are likely to offer inferior protection, costing you more in replacements and compromising safety.
- Not all cut resistant products offer high levels of tear, puncture or abrasion resistance: significant additional factors for safety.
- It is lightweight, comfortable and fully washable, making it a practical solution to personal protection.
- All CutPRO® garments can be customised to reflect unique operational risks and needs, role responsibilities, branding and design preferences.



Visit our website: www.cut-pro.com

T: +44 (0) 845 5193 953 | E: info@cut-pro.com

About Cut-Tex® PRO

Cut-Tex® PRO

The Ultimate Cut Protection™

Cut-Tex® PRO is an ultra-high performance cut and slash resistant fabric, comfortable to wear, fully machine washable and of truly exceptional strength and durability - making it the ideal material for CutPRO® Cut Resistant Clothing.

As you can see below, Cut-Tex® PRO performs very highly in all cut, abrasion, tear and puncture tests:

Cut-Tex® PRO Performance Chart:

> **Cut Resistance** - ANSI/ISEA 2016 Blade Resistance Levels A1-A9



> **Abrasion Resistance** - EN 388:2016 Abrasion Resistance Levels 1-4



> **Cut Resistance** - EN 388:2003 (coupe test) Cut Resistance Levels 1-5



> **Tear Resistance** - EN 388:2016 Tear Resistance Levels 1-4



> **Puncture Resistance** - EN 388:2016 Puncture Resistance Levels 1-4



> **Cut Resistance** - EN ISO 13997 (TDM-100 Test)



Visit our website: www.cut-pro.com

T: +44 (0) 845 5193 953 | E: info@cut-pro.com



Product: CutPRO® Pull Over Top with Half Zip Turtle Neck

Model #: 100210



CutPRO® Cut Resistant Tops are manufactured using Cut-Tex® PRO, offering outstanding tested and certified levels of cut, abrasion, tear and puncture resistance.



Features and Benefits

- Cut-Tex® PRO is used to provide excellent cut resistance
- Full front, neck and arm protection
- Breathable polyester back
- Thumb holes
- 8" length zip
- Shoulder and elbow patches
- 100% latex free

Bespoke features available – please contact us for further details

- Logo embroidery
- 1" or 2" collars
- Thumb loops
- Additional pockets
- Hi-Vis tape
- Colour options for non-Cut-Tex® PRO areas

Suitable for professionals working in the following industries:

- Glass and glazing
- Metal
- Ceramics
- Industrial manufacturing
- Recycling

■ Protective areas using 100% Cut-Tex® PRO

□ Non-protected areas



Material Content

Cut-Tex® PRO, Polyester, Cotton

Cut Resistance

EN 388:2003 (coupe test) Level 5

EN ISO 13997 (TDM-100 Test) Level E

ANSI/ISEA 2016 Level A5

Abrasion Resistance

EN 388:2016 Level 3

Tear Resistance

EN 388:2016 Level 4

Puncture Resistance

EN 388:2016 Level 4

Sizes S - 5XL

Colour Cut-Tex® PRO - Grey Marl
Piping - Orange
Polycotton - Grey or Navy



Place of Manufacture EU - CE PPE Regulation (EU) 2016/425 - Pending



CutPRO® branded products are unavailable in Canada, please contact us for other available branding options.
Notified Body BTTG Testing & Certification (0388)



Visit our website: www.cut-pro.com

T: +44 (0) 845 5193 953 | E: info@cut-pro.com



Product: CutPRO® Pull Over Top with Workwear Collar

Model #: 100211

CutPRO® Cut Resistant Tops are manufactured using Cut-Tex® PRO, offering outstanding tested and certified levels of cut, abrasion, tear and puncture resistance.



Features and Benefits

- Cut-Tex® PRO is used to provide excellent cut resistance
- Front and arm protection
- Breathable polyester back
- Thumb holes
- Zipped kangaroo pocket
- Breast pocket
- Workwear collar
- 100% latex free

Bespoke features available – please contact us for further details

- Logo embroidery
- Thumb loops
- Buttoned collar
- Additional pockets
- Hi-Vis tape
- Colour options for non-Cut-Tex® PRO fabrics

Suitable for professionals working in the following industries:

- Glass and glazing
- Metal
- Ceramics
- Industrial manufacturing
- Recycling

■ Protective areas using 100% Cut-Tex® PRO

□ Non-protected areas

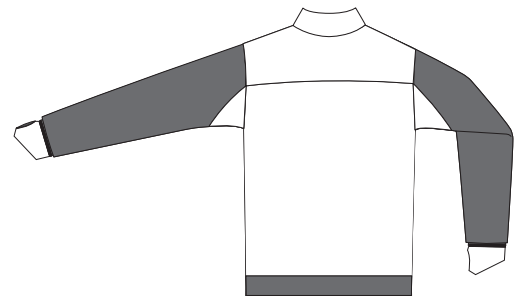
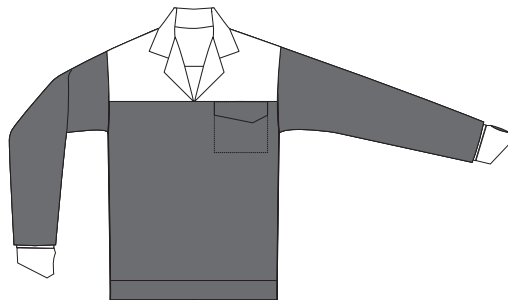

Material Content

Cut-Tex® PRO, Polyester, Cotton

Cut Resistance

EN 388:2003 (coupe test) Level 5

EN ISO 13997 (TDM-100 Test) Level E

ANSI/ISEA 2016 Level A5

Abrasion Resistance

EN 388:2016 Level 3

Tear Resistance

EN 388:2016 Level 4

Puncture Resistance

EN 388:2016 Level 4

Sizes

S - 5XL

Colour

Cut-Tex® PRO - Grey Marl
Piping - Orange
Polycotton - Grey or Navy



Place of Manufacture

EU - CE PPE Regulation (EU) 2016/425 - Pending



CutPRO® branded products are unavailable in Canada, please contact us for other available branding options.
Notified Body BTTG Testing & Certification (0388)



Visit our website: www.cut-pro.com

T: +44 (0) 845 5193 953 | E: info@cut-pro.com



Product: CutPRO® Sweatshirt with Crew Neck

Model #: 100218



CutPRO® Cut Resistant Tops are manufactured using Cut-Tex® PRO, offering outstanding tested and certified levels of cut, abrasion, tear and puncture resistance.



Features and Benefits

- Cut-Tex® PRO is used to provide excellent cut resistance
- Full front, arms and shoulder protection
- Breathable polyester back and underarms
- Thumb holes
- Crew neck
- 100% latex free

Bespoke features available – please contact us for further details

- Logo embroidery
- Thumb loops
- Additional pockets
- Hi-Vis tape
- Colour options for non-Cut-Tex® PRO fabrics

Suitable for professionals working in the following industries:

- Glass and glazing
- Metal
- Ceramics
- Industrial manufacturing
- Recycling

Material Content

Cut-Tex® PRO, Polyester

Cut Resistance

EN 388:2003 (coupe test) Level 5

EN ISO 13997 (TDM-100 Test) Level E

ANSI/ISEA 2016 Level A5

Abrasion Resistance

EN 388:2016 Level 3

Tear Resistance

EN 388:2016 Level 4

Puncture Resistance

EN 388:2016 Level 4

Sizes

S - 5XL

Colour

Cut-Tex® PRO - Grey Marl
Polyester - Black, Grey, Orange, Yellow



Place of Manufacture

EU - CE PPE Regulation (EU) 2016/425 - Pending



■ Protective areas using 100% Cut-Tex® PRO

□ Non-protected areas

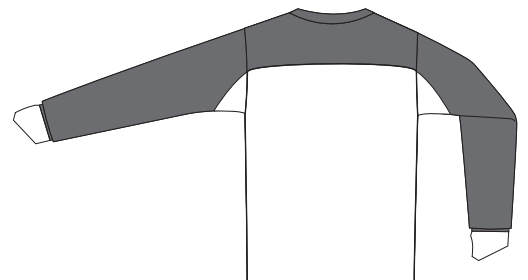
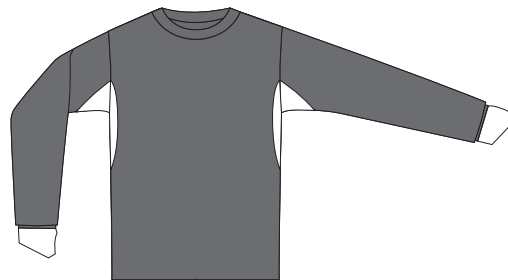

CutPRO® branded products are unavailable in Canada, please contact us for other available branding options.
Notified Body BTTG Testing & Certification (0388)



Visit our website: www.cut-pro.com

T: +44 (0) 845 5193 953 | E: info@cut-pro.com



Product: CutPRO® Sweatshirt with Turtle Neck

Model #: 100209



CutPRO® Cut Resistant Tops are manufactured using Cut-Tex® PRO, offering outstanding tested and certified levels of cut, abrasion, tear and puncture resistance.



Features and Benefits

- Cut-Tex® PRO is used to provide excellent cut resistance
- Full front, arms, neck and shoulder protection
- Breathable polyester back and underarms
- Thumb holes
- 100% latex free

Bespoke features available – please contact us for further details

- Logo embroidery
- 1" or 2" collars
- Thumb loops
- Additional pockets
- Hi-Vis tape
- Colour options for non-Cut-Tex® PRO fabrics

Suitable for professionals working in the following industries:

- Glass and glazing
- Metal
- Ceramics
- Industrial manufacturing
- Recycling

Material Content

Cut-Tex® PRO, Polyester

Cut Resistance

EN 388:2003 (coupe test) Level 5

EN ISO 13997 (TDM-100 Test) Level E

ANSI/ISEA 2016 Level A5

Abrasion Resistance

EN 388:2016 Level 3

Tear Resistance

EN 388:2016 Level 4

Puncture Resistance

EN 388:2016 Level 4

Sizes S - 5XL

Colour

Cut-Tex® PRO - Grey Marl
Polyester - Black, Grey, Orange, Yellow



Place of Manufacture EU - CE PPE Regulation (EU) 2016/425 - Pending

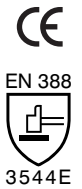

■ Protective areas using 100% Cut-Tex® PRO

□ Non-protected areas

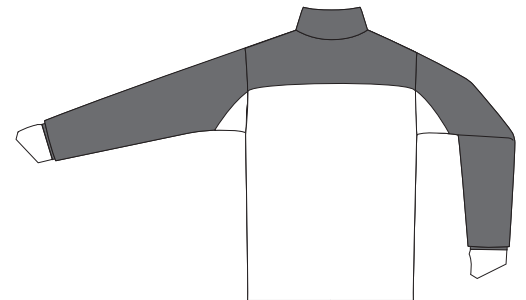
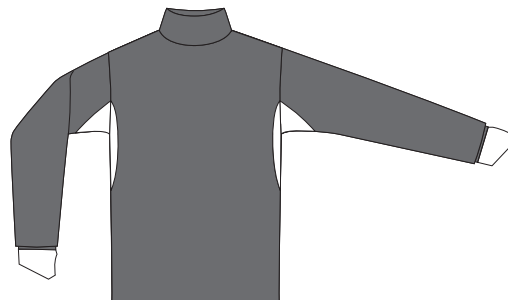

CutPRO® branded products are unavailable in Canada, please contact us for other available branding options.
Notified Body BTTG Testing & Certification (0388)



Visit our website: www.cut-pro.com

T: +44 (0) 845 5193 953 | E: info@cut-pro.com



Product: CutPRO® Zipped Jacket with Hi-Vis Tape

Model #: 100200



CutPRO® Cut Resistant Jackets are manufactured using Cut-Tex® PRO, offering outstanding tested and certified levels of cut, abrasion, tear and puncture resistance.



Features and Benefits

- Cut-Tex® PRO is used to provide excellent cut resistance
- Full front, arms, neck and shoulder protection
- Breathable polyester back
- Thumb holes
- Hi-Vis tape
- Full front zip
- 100% latex free

Bespoke features available – please contact us for further details

- Logo embroidery
- 1" or 2" collars
- Thumb loops
- Additional pockets
- Hi-Vis tape optional
- Colour options for non-Cut-Tex® PRO fabrics

Suitable for professionals working in the following industries:

- Glass and glazing
- Metal
- Ceramics
- Industrial manufacturing
- Recycling

■ Protective areas using 100% Cut-Tex® PRO

□ Non-protected areas

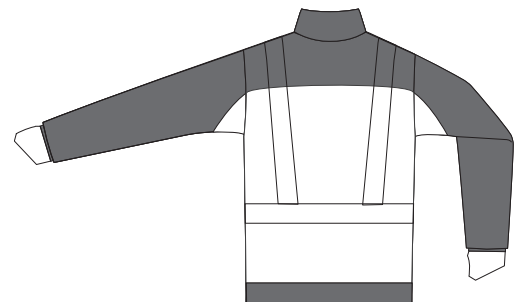

Material Content

Cut-Tex® PRO, Polyester

Cut Resistance

EN 388:2003 (coupe test) Level 5

EN ISO 13997 (TDM-100 Test) Level E

ANSI/ISEA 2016 Level A5

Abrasion Resistance

EN 388:2016 Level 3

Tear Resistance

EN 388:2016 Level 4

Puncture Resistance

EN 388:2016 Level 4

Sizes S - 5XL

Colour Cut-Tex® PRO - Grey Marl
Polyester - Black, Grey, Orange, Yellow



Place of Manufacture EU - CE PPE Regulation (EU) 2016/425 - Pending



3544E



Visit our website: www.cut-pro.com

T: +44 (0) 845 5193 953 | E: info@cut-pro.com



Product: CutPRO® Top with Crew Neck and Belly Patch

Model #: 100201



CutPRO® Cut Resistant Tops are manufactured using Cut-Tex® PRO, offering outstanding tested and certified levels of cut, abrasion, tear and puncture resistance.



Features and Benefits

- Cut-Tex® PRO is used to provide excellent cut resistance
- Abdominal and forearm protection
- Breathable polyester chest, shoulders and back
- Thumb loops
- Crew neck
- 100% latex free

Bespoke features available – please contact us for further details

- Logo embroidery
- Thumb holes
- Additional pockets
- Hi-Vis tape
- Available without belly patch
- Colour options for non-Cut-Tex® PRO fabrics

Suitable for professionals working in the following industries:

- Glass and glazing
- Metal
- Ceramics
- Industrial manufacturing
- Recycling

■ **Protective areas using 100% Cut-Tex® PRO**

□ **Non-protected areas**

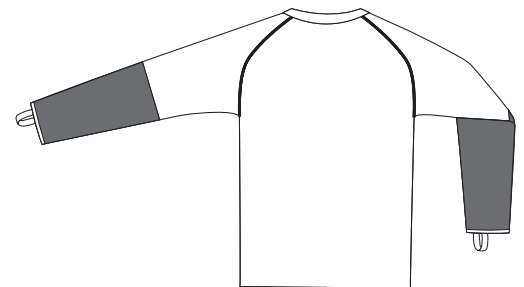
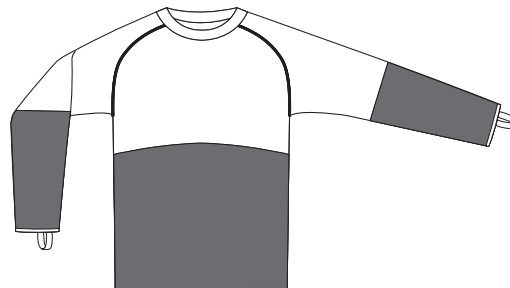

Material Content

Cut-Tex® PRO, Polyester

Cut Resistance

EN 388:2003 (coupe test) Level 5

EN ISO 13997 (TDM-100 Test) Level E

ANSI/ISEA 2016 Level A5

Abrasion Resistance

EN 388:2016 Level 3

Tear Resistance

EN 388:2016 Level 4

Puncture Resistance

EN 388:2016 Level 4

Sizes S - 5XL

Colour

Cut-Tex® PRO - Grey Marl
Polyester - Black, Grey,
Orange, Yellow



Place of Manufacture

EU - CE PPE Regulation (EU) 2016/425 - Pending



3544E



Visit our website: www.cut-pro.com

T: +44 (0) 845 5193 953 | E: info@cut-pro.com



Product: CutPRO® Top with Half Zip Neck and Belly Patch

Model #: 100219



CutPRO® Cut Resistant Tops are manufactured using Cut-Tex® PRO, offering outstanding tested and certified levels of cut, abrasion, tear and puncture resistance.



Features and Benefits

- Cut-Tex® PRO is used to provide excellent cut resistance
- Abdominal and forearm protection
- Breathable polyester chest, shoulders and back
- Thumb loops
- ¼ length zip
- 100% latex free

Bespoke features available – please contact us for further details

- Logo embroidery
- Thumb holes
- Additional pockets
- Hi-Vis tape
- Available without belly patch
- Colour options for non-Cut-Tex® PRO fabrics

Suitable for professionals working in the following industries:

- Glass and glazing
- Metal
- Ceramics
- Industrial manufacturing
- Recycling

Protective areas using 100% Cut-Tex® PRO

Non-protected areas



Material Content

Cut-Tex® PRO, Polyester

Cut Resistance

EN 388:2003 (coupe test)	Level 5
EN ISO 13997 (TDM-100 Test)	Level E
ANSI/ISEA 2016	Level A5

Abrasion Resistance

EN 388:2016	Level 3
-------------	---------

Tear Resistance

EN 388:2016	Level 4
-------------	---------

Puncture Resistance

EN 388:2016	Level 4
-------------	---------

Sizes	S - 5XL
-------	---------

Colour	Cut-Tex® PRO - Grey Marl Polyester - Black, Grey, Orange, Yellow
--------	--



Place of Manufacture	EU - CE PPE Regulation (EU) 2016/425 - Pending
----------------------	--

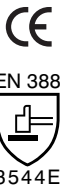

CutPRO® branded products are unavailable in Canada, please contact us for other available branding options.
Notified Body BTTG Testing & Certification (0388)



Visit our website: www.cut-pro.com

T: +44 (0) 845 5193 953 | E: info@cut-pro.com



Product: CutPRO® Crew Neck Armguard Shirt

Model #: 100212



CutPRO® Cut Resistant Tops are manufactured using Cut-Tex® PRO, offering outstanding tested and certified levels of cut, abrasion, tear and puncture resistance.



Features and Benefits

- Cut-Tex® PRO is used to provide excellent cut resistance
- Full arm and shoulder protection
- Breathable polyester front and back
- Thumb loops
- 100% latex free

Bespoke features available – please contact us for further details

- Logo embroidery
- Thumbhole
- Additional pockets
- Hi-Vis tape
- Available with belly patch
- Zip collar
- Colour options for non-Cut-Tex® PRO fabrics

Suitable for professionals working in the following industries:

- Glass and glazing
- Metal
- Ceramics
- Industrial manufacturing
- Recycling

■ **Protective areas using 100% Cut-Tex® PRO**

□ **Non-protected areas**

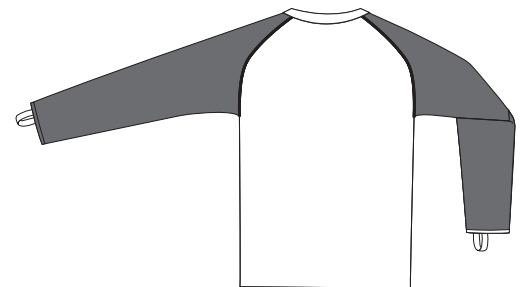
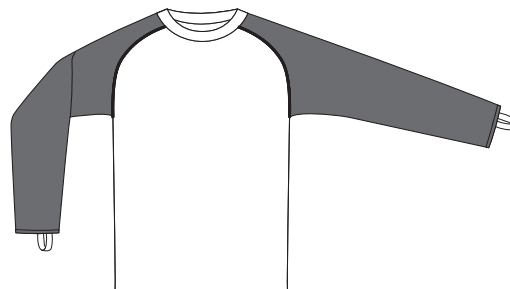

Material Content

Cut-Tex® PRO, Polyester

Cut Resistance

EN 388:2003 (coupe test) Level 5

EN ISO 13997 (TDM-100 Test) Level E

ANSI/ISEA 2016 Level A5

Abrasion Resistance

EN 388:2016 Level 3

Tear Resistance

EN 388:2016 Level 4

Puncture Resistance

EN 388:2016 Level 4

Sizes S - 5XL

Colour

Cut-Tex® PRO - Grey Marl
Polyester - Black, Grey,
Orange, Yellow



Place of Manufacture EU - CE PPE Regulation (EU) 2016/425 - Pending



3544E

CutPRO® branded products are unavailable in Canada, please contact us for other available branding options.
Notified Body BTTG Testing & Certification (0388)



Visit our website: www.cut-pro.com

T: +44 (0) 845 5193 953 | E: info@cut-pro.com



Product: CutPRO® Polo Shirt with Belly Patch

Model #: 100203

CutPRO® Cut Resistant Polo Shirts are manufactured using Cut-Tex® PRO, offering outstanding tested and certified levels of cut, abrasion, tear and puncture resistance.



Features and Benefits

- Cut-Tex® PRO is used to provide excellent cut resistance
- Abdominal and forearm protection
- Comfort cotton pique
- Thumb loops
- Buttoned Collar
- 100% latex free

Bespoke features available – please contact us for further details

- Logo embroidery
- Thumb holes
- Additional pockets
- Hi-Vis tape
- Colour options for non-Cut-Tex® PRO fabrics

Suitable for professionals working in the following industries:

- Glass and glazing
- Metal
- Ceramics
- Industrial manufacturing
- Recycling

Protective areas using 100% Cut-Tex® PRO

Non-protected areas

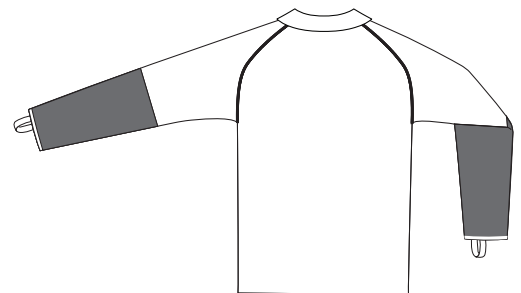

Material Content

Cut-Tex® PRO, Cotton Pique

Cut Resistance

EN 388:2003 (coupe test)	Level 5
EN ISO 13997 (TDM-100 Test)	Level E
ANSI/ISEA 2016	Level A5

Abrasion Resistance

EN 388:2016	Level 3
-------------	---------

Tear Resistance

EN 388:2016	Level 4
-------------	---------

Puncture Resistance

EEN 388:2016	Level 4
--------------	---------

Sizes	S - 5XL
-------	---------

Colour	Cut-Tex® PRO - Grey Marl Cotton Pique - Black, Grey, Royal Blue
--------	---



Place of Manufacture	EU - CE PPE Regulation (EU) 2016/425 - Pending
----------------------	--

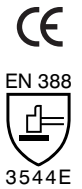

CutPRO® branded products are unavailable in Canada, please contact us for other available branding options.
Notified Body BTTG Testing & Certification (0388)



Visit our website: www.cut-pro.com

T: +44 (0) 845 5193 953 | E: info@cut-pro.com



Product: CutPRO® Polo Shirt without Belly Patch

Model #: 100204



CutPRO® Cut Resistant Polo Shirts are manufactured using Cut-Tex® PRO, offering outstanding tested and certified levels of cut, abrasion, tear and puncture resistance.

Features and Benefits

- Cut-Tex® PRO is used to provide excellent cut resistance
- Forearm protection
- Comfort cotton pique
- Thumb loops
- Buttoned Collar
- 100% latex free

Bespoke features available – please contact us for further details

- Logo embroidery
- Thumb holes
- Additional pockets
- Hi-Vis tape
- Colour options for non-Cut-Tex® PRO fabrics

Suitable for professionals working in the following industries:

- Glass and glazing
- Metal
- Ceramics
- Industrial manufacturing
- Recycling

■ **Protective areas using 100% Cut-Tex® PRO**

□ **Non-protected areas**

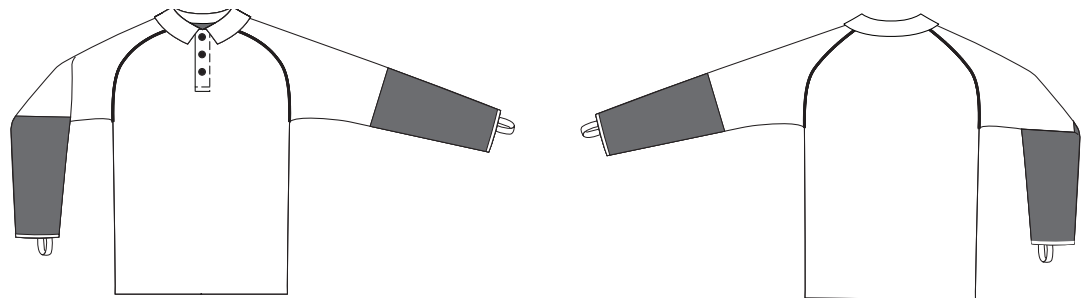

Material Content

Cut-Tex® PRO, Cotton Pique

Cut Resistance

EN 388:2003 (coupe test) Level 5

EN ISO 13997 (TDM-100 Test) Level E

ANSI/ISEA 2016 Level A5

Abrasion Resistance

EN 388:2016 Level 3

Tear Resistance

EN 388:2016 Level 4

Puncture Resistance

EN 388:2016 Level 4

Sizes S - 5XL

Colour

Cut-Tex® PRO - Grey Marl
Cotton Pique - Black, Grey, Royal Blue



Place of Manufacture

EU - CE PPE Regulation (EU) 2016/425 - Pending

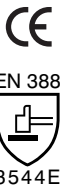

CutPRO® branded products are unavailable in Canada, please contact us for other available branding options.
Notified Body BTTG Testing & Certification (0388)



Visit our website: www.cut-pro.com

T: +44 (0) 845 5193 953 | E: info@cut-pro.com

Product: CutPRO® Lab Coat

Model #: 100207



CutPRO® Cut Resistant Coats are manufactured using Cut-Tex® PRO – offering absolutely outstanding, tested and certified levels of cut, abrasion, tear and puncture resistance.



Features and Benefits

- Cut-Tex® PRO is used to provide excellent cut resistance
- Full front, neck, shoulder and arm protection
- Cool mesh back
- Inside breast pocket
- Full front zip with added Velcro
- 100% latex free

Bespoke features available – please contact us for further details

- Logo embroidery
- Thumb loops
- Additional pockets
- Hi-Vis tape
- Colour options for non-Cut-Tex® PRO fabrics

Suitable for professionals working in the following industries:

- Glass and glazing
- Metal
- Ceramics
- Industrial manufacturing
- Recycling

■ **Protective areas using 100% Cut-Tex® PRO**

□ **Non-protected areas**

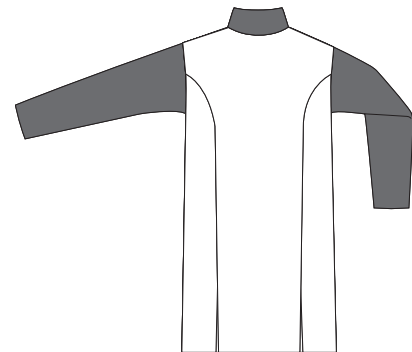

Material Content

Cut-Tex® PRO, Nylon

Cut Resistance

EN 388:2003 (coupe test) Level 5

EN ISO 13997 (TDM-100 Test) Level E

ANSI/ISEA 2016 Level A5

Abrasion Resistance

EN 388:2016 Level 3

Tear Resistance

EN 388:2016 Level 4

Puncture Resistance

EN 388:2016 Level 4

Sizes S - 5XL

Colour Cut-Tex® PRO - Grey Marl

Place of Manufacture EU - CE PPE Regulation (EU) 2016/425 - Pending

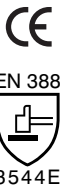

CutPRO® branded products are unavailable in Canada, please contact us for other available branding options.
Notified Body BTTG Testing & Certification (0388)



Product: CutPRO® Trousers with Front and Back Protection

Model #: 100216



CutPRO® Cut Resistant Trousers are manufactured using Cut-Tex® PRO – offering absolutely outstanding, tested and certified levels of cut, abrasion, tear and puncture resistance.



Features and Benefits

- Cut-Tex® PRO is used to provide excellent cut resistance
- Full front, lower back leg and groin protection
- Knee patches
- Hi-Vis piping
- Belt loops
- Rear pockets
- Side leg pocket
- D-ring attachment
- 100% latex free

Bespoke features available – please contact us for further details

- Additional pockets
- Colour options for non-Cut-Tex® PRO fabrics

Suitable for professionals working in the following industries:

- Glass and glazing
- Metal
- Ceramics
- Industrial manufacturing
- Recycling

Protective areas using 100% Cut-Tex® PRO

Non-protected areas

Material Content

Cut-Tex® PRO, Nylon, Polyester, Cotton

Cut Resistance

EN 388:2003 (coupe test) Level 5

EN ISO 13997 (TDM-100 Test) Level E

ANSI/ISEA 2016 Level A5

Abrasion Resistance

EN 388:2016 Level 3

Tear Resistance

EN 388:2016 Level 4

Puncture Resistance

EN 388:2016 Level 4

Sizes

Waist: 30"/32"/34"/36"/38"/40"/42"/44"/46"/48"
Length: 29"/31"/33"

Colour

Cut-Tex® PRO - Grey Marl
Piping - Orange
Polycotton - Grey or Navy



Place of Manufacture

EU - CE PPE Regulation (EU) 2016/425 - Pending

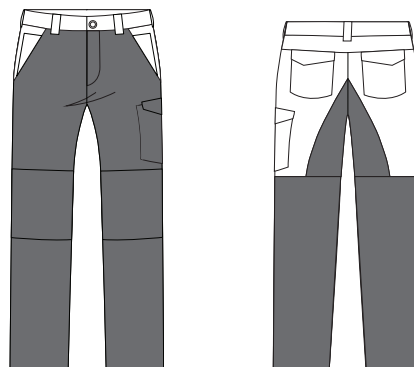
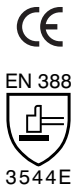

CutPRO® branded products are unavailable in Canada, please contact us for other available branding options.
Notified Body BTTG Testing & Certification (0388)



Visit our website: www.cut-pro.com

T: +44 (0) 845 5193 953 | E: info@cut-pro.com



Product: CutPRO® Trousers with Front Protection

Model #: 100206

CutPRO® Cut Resistant Trousers are manufactured using Cut-Tex® PRO – offering absolutely outstanding, tested and certified levels of cut, abrasion, tear and puncture resistance.



Features and Benefits

- Cut-Tex® PRO is used to provide excellent cut resistance
- Full front leg protection
- Knee patches
- Hi-Vis piping
- Belt loops
- Front and rear pockets
- Side leg pocket
- D-ring attachment
- 100% latex free

Bespoke features available – please contact us for further details

- Additional pockets
- Colour options for non-Cut-Tex® PRO fabrics

Suitable for professionals working in the following industries:

- Glass and glazing
- Metal
- Ceramics
- Industrial manufacturing
- Recycling

 **Protective areas using 100% Cut-Tex® PRO**

 **Non-protected areas**

Material Content

Cut-Tex® PRO, Nylon, Polyester, Cotton

Cut Resistance

EN 388:2003 (coupe test) Level 5

EN ISO 13997 (TDM-100 Test) Level E

ANSI/ISEA 2016 Level A5

Abrasion Resistance

EN 388:2016 Level 3

Tear Resistance

EN 388:2016 Level 4

Puncture Resistance

EN 388:2016 Level 4

Sizes

Waist: 30"/32"/34"/36"/38"/40"/42"/44"/46"/48"
Length: 29"/31"/33"

Colour

Cut-Tex® PRO - Grey Marl
Piping - Orange
Polycotton - Grey or Navy



Place of Manufacture

EU - CE PPE Regulation (EU) 2016/425 - Pending

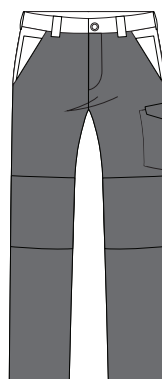
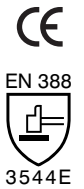

CutPRO® branded products are unavailable in Canada, please contact us for other available branding options.
Notified Body BTTG Testing & Certification (0388)



Visit our website: www.cut-pro.com

T: +44 (0) 845 5193 953 | E: info@cut-pro.com



Product: CutPRO® Pull on Sleeve

Model #: 100205



CutPRO® Cut Resistant Pull on Sleeves are manufactured using Cut-Tex® PRO – offering absolutely outstanding, tested and certified levels of cut, abrasion, tear and puncture resistance.

Features and Benefits

- Cut-Tex® PRO is used to provide excellent cut resistance
- Forearm protection
- Thumb holes
- 100% latex free

Bespoke features available – please contact us for further details

- Logo embroidery
- Colours options for non-Cut-Tex® PRO fabrics
- Various lengths

Suitable for professionals working in the following industries:

- Glass and glazing
- Metal
- Ceramics
- Industrial manufacturing
- Recycling

Material Content Cut-Tex® PRO, Polyester

Cut Resistance

EN 388:2003 (coupe test)	Level 5
EN ISO 13997 (TDM-100 Test)	Level E
ANSI/ISEA 2016	Level A5

Abrasion Resistance

EN 388:2016	Level 3
-------------	---------

Tear Resistance

EN 388:2016	Level 4
-------------	---------

Puncture Resistance

EN 388:2016	Level 4
-------------	---------

Sizes	S - XL
-------	--------

Colour	Cut-Tex® PRO - Grey Marl
--------	--------------------------

Place of Manufacture	EU - CE PPE Regulation (EU) 2016/425 - Pending
----------------------	--



Protective areas using 100% Cut-Tex® PRO

Non-protected areas

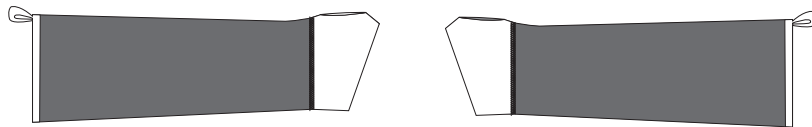

This CutPRO® branded product is unavailable in the US, please contact us for other available branding.
 CutPRO® branded products are unavailable in Canada, please contact us for other available branding options.
 Notified Body BTTG Testing & Certification (0388)



Visit our website: www.cut-pro.com

T: +44 (0) 845 5193 953 | E: info@cut-pro.com



Product: CutPRO® Full Length Apron

Model #: 100213



CutPRO® Cut Resistant Aprons are manufactured using Cut-Tex® PRO – offering absolutely outstanding, tested and certified levels of cut, abrasion, tear and puncture resistance.

Features and Benefits

- Cut-Tex® PRO is used to provide excellent cut resistance
- Full cut protection
- Clip-on adjustable straps
- 100% latex free

Bespoke features available – please contact us for further details

- Logo embroidery
- Pockets
- Hi-Vis tape

Suitable for professionals working in the following industries:

- Glass and glazing
- Metal
- Ceramics
- Industrial manufacturing
- Recycling

Material Content

Cut-Tex® PRO, Nylon, Polyester, Cotton

Cut Resistance

EN 388:2003 (coupe test) Level 5

EN ISO 13997 (TDM-100 Test) Level E

ANSI/ISEA 2016 Level A5

Abrasion Resistance

EN 388:2016 Level 3

Tear Resistance

EN 388:2016 Level 4

Puncture Resistance

EN 388:2016 Level 4

Sizes One size

Colour Cut-Tex® PRO - Grey Marl

Place of Manufacture EU - CE PPE Regulation (EU) 2016/425 - Pending



Protective areas using 100% Cut-Tex® PRO



Non-protected areas



This CutPRO® branded product is unavailable in the US, please contact us for other available branding.
 CutPRO® branded products are unavailable in Canada, please contact us for other available branding options.
 Notified Body BTTG Testing & Certification (0388)



Visit our website: www.cut-pro.com

T: +44 (0) 845 5193 953 | E: info@cut-pro.com



Product: CutPRO® Half Apron

Model #: 100214



CutPRO® Cut Resistant Aprons are manufactured using Cut-Tex® PRO – offering absolutely outstanding, tested and certified levels of cut, abrasion, tear and puncture resistance.

Features and Benefits

- Cut-Tex® PRO is used to provide excellent cut resistance
- Full cut protection
- Various sized pockets
- Clip-on adjustable strap
- 100% latex free

Bespoke features available – please contact us for further details

- Logo embroidery
- Additional pockets
- Hi-Vis tape

Suitable for professionals working in the following industries:

- Glass and glazing
- Metal
- Ceramics
- Industrial manufacturing
- Recycling



Protective areas using 100% Cut-Tex® PRO



Non-protected areas

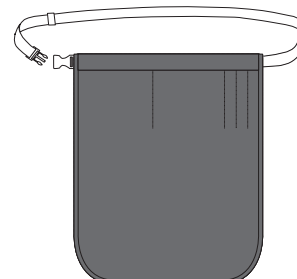
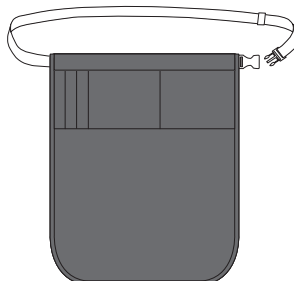

Material Content

Cut-Tex® PRO, Nylon, Polyester, Cotton

Cut Resistance

EN 388:2003 (coupe test) Level 5

EN ISO 13997 (TDM-100 Test) Level E

ANSI/ISEA 2016 Level A5

Abrasion Resistance

EN 388:2016 Level 3

Tear Resistance

EN 388:2016 Level 4

Puncture Resistance

EN 388:2016 Level 4

Sizes One size

Colour Cut-Tex® PRO - Grey Marl

Place of Manufacture EU - CE PPE Regulation (EU) 2016/425 - Pending



This CutPRO® branded product is unavailable in the US, please contact us for other available branding.
 CutPRO® branded products are unavailable in Canada, please contact us for other available branding options.
 Notified Body BTTG Testing & Certification (0388)



Visit our website: www.cut-pro.com

T: +44 (0) 845 5193 953 | E: info@cut-pro.com



Product: CutPRO® Split Apron

Model #: 100215

CutPRO® Cut Resistant Aprons are manufactured using Cut-Tex® PRO – offering absolutely outstanding, tested and certified levels of cut, abrasion, tear and puncture resistance.



Features and Benefits

- Cut-Tex® PRO is used to provide excellent cut resistance
- Full cut protection
- Clip-on adjustable straps
- 100% latex free

Bespoke features available – please contact us for further details

- Logo embroidery
- Additional pockets
- Hi-Vis tape

Suitable for professionals working in the following industries:

- Glass and glazing
- Metal
- Ceramics
- Industrial manufacturing
- Recycling

Material Content

Cut-Tex® PRO, Nylon, Polyester, Cotton

Cut Resistance

EN 388:2003 (coupe test) Level 5

EN ISO 13997 (TDM-100 Test) Level E

ANSI/ISEA 2016 Level A5

Abrasion Resistance

EN 388:2016 Level 3

Tear Resistance

EN 388:2016 Level 4

Puncture Resistance

EN 388:2016 Level 4

Sizes One size

Colour Cut-Tex® PRO - Grey Marl

Place of Manufacture EU - CE PPE Regulation (EU) 2016/425 - Pending



■ Protective areas using 100% Cut-Tex® PRO

□ Non-protected areas

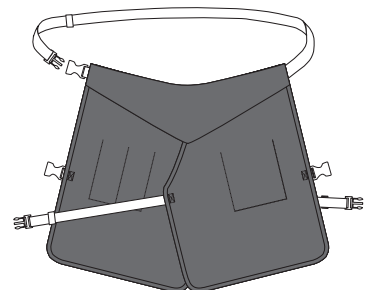
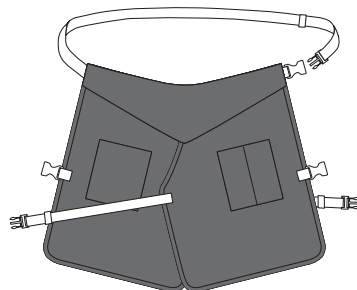

This CutPRO® branded product is unavailable in the US, please contact us for other available branding.
 CutPRO® branded products are unavailable in Canada, please contact us for other available branding options.
 Notified Body BTTG Testing & Certification (0388)



Visit our website: www.cut-pro.com

T: +44 (0) 845 5193 953 | E: info@cut-pro.com



Size Guide

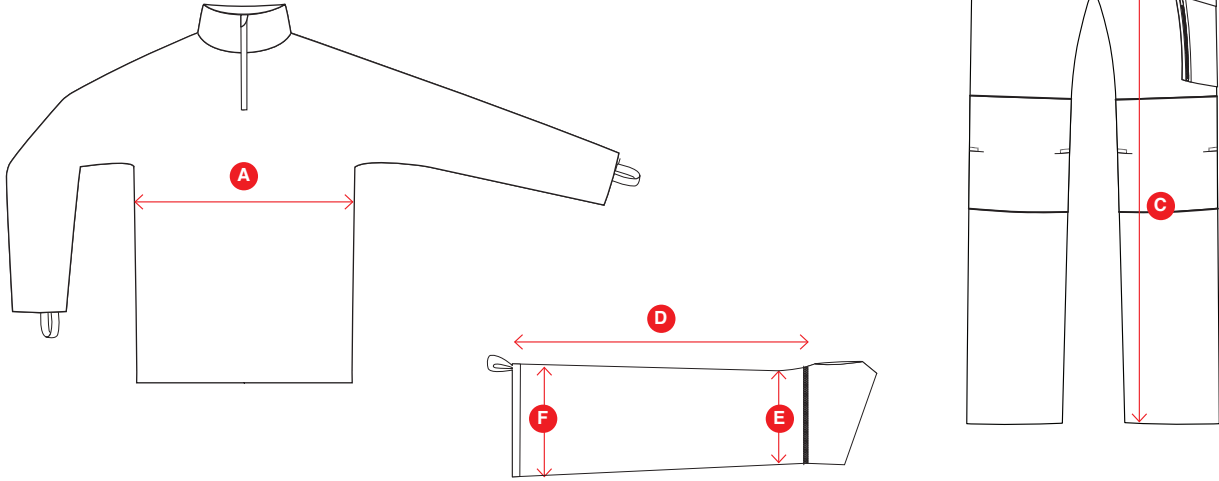

CutPRO® Chest – Size Guide

	S	M	L	XL	2XL	3XL	4XL	5XL
A To fit CHEST (inches)	38-40"	40-42"	42-44"	44-46"	46-48"	48-50"	50-52"	52-54"
To fit CHEST (cm)	92-102	102-107	107-112	112-117	117-120	120-127	127-132	132-137

CutPRO® Waist – Size Guide

B Waist Size (inches)	30"	32"	34"	36"	38"	40"	42"	44"	46"	48"
Waist Size (cm)	76	81	86	91	96	101	106	111	116	121
Short Leg to fit 29"/76cm	N/A	N/A	29"	29"	29"	29"	29"	29"	N/A	N/A
Regular Leg to fit 31"/81cm	N/A	31"	31"	31"	31"	31"	31"	31"	31"	31"
Tall Leg to fit 33"/86cm	33"	33"	33"	33"	33"	33"	33"	33"	N/A	N/A

CutPRO® Sleeve – Size Guide

Size	S	M	L	XL
D Actual Sleeve Length (cm)	30	32	33	34
E Actual Cuff Width - flat (cm)	9	10	11	12
F Actual Arm Width - flat (cm)	11	12	13	14

CutPRO® Apron (all with fully adjustable straps) – Size Guide

Product	Full Apron 100213	Half Apron 100214	Split Apron 100215
Actual width (cm) - waist	60	60	60
Actual length (cm)	90	75	55



Visit our website: www.cut-pro.com

T: +44 (0) 845 5193 953 | E: info@cut-pro.com

Important Information

- Do not use this product for protection from high speed or serrated blade
- Do not use this product near moving machines or where there is a risk of entanglement
- Do not use this product for food processing
- This product is designed to minimise the risk of injury from potential hazards in the industrial work space (abrasions, cuts, tears and puncture)
- This product is used only for the designated purpose, no item of PPE can provide full protection
- This product is not designed to protect the hands, gloves are to be worn when required
- This product does not protect from hypodermic needles or similar sharp pointed objects
- Care and attention must always be taken when carrying out potential hazardous activities
- Cut-Tex® PRO is an ultra-high performance cut resistant fabric. However, it is not completely cut proof.

Maintenance

- Do not wear this product if damaged, always inspect prior to use
- Do not leave in a contaminated condition, launder immediately
- When not worn, store this product in cool dry conditions away from direct sunlight
- Wash dark colours separately
- Do not wash with fabric conditioner
- Reshape whilst damp



Contact

CutPRO® Cut Resistant Clothing is part of PPSS Group

PPSS Group

Whitfield Business Park
Unit 1-2, Manse Lane
Knaresborough
HG5 8BS
United Kingdom

T: **+44 (0) 845 5193 953**

E: **info@ppss-group.com**

W: **www.ppss-group.com**



Visit our website: www.cut-pro.com

T: +44 (0) 845 5193 953 | E: info@cut-pro.com